City of Rockville
Department of Public Works
Parks and Facilities Division



2018 BRIDGE INSPECTION REPORT
August 22, 2018



BRIDGE NO. PB-050
KING FARM PARK
OVER
TRIBUTARY TO WATTS BRANCH

Prepared by

EBA^{OD}
ENGINEERING

CITY OF ROCKVILLE
Department of Public Works
Parks and Facilities Division

2018 BRIDGE INSPECTION REPORT
BRIDGE NO. PB-050

KING FARM PARK

OVER

TRIBUTARY TO WATTS BRANCH

Prepared by

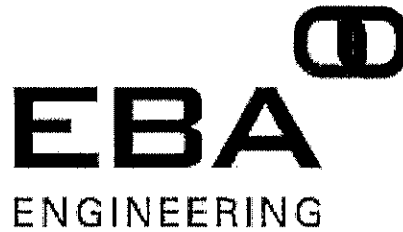

A handwritten signature in black ink, appearing to read "Jeffery Evans", written over a horizontal line.

Inspection Team Leader: Jeffery M.R. Evans, P.E.

12-13-18

Date

A handwritten signature in black ink, appearing to read "Cara Johnson", written over a horizontal line.

Quality Assurance: Cara I. Johnson, P.E.

12/13/2018

Date

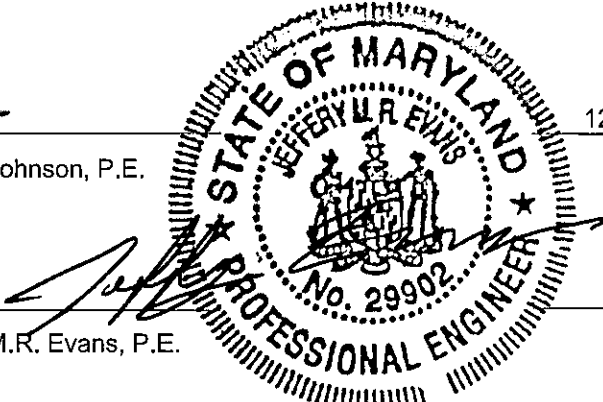

Professional Engineer: Jeffery M.R. Evans, P.E.

12-13-18

Date

Professional Certification - I hereby certify that these documents were prepared or approved by me, and that I am a duly licensed professional engineer under the laws of the State of Maryland, License No. 29902, Expiration Date: January 8, 2020.

**CITY OF ROCKVILLE
Department of Public Works
Parks and Facilities Division
2018 BRIDGE INSPECTION REPORT**

BRIDGE NO. PB-050

KING FARM PARK OVER TRIBUTARY TO WATTS BRANCH

TABLE OF CONTENTS

	Page
LOCATION MAP	1
BRIDGE SKETCHES	2
BRIDGE DESCRIPTION SUMMARY	3
COMPARATIVE EVALUATION SUMMARY TABLE	4
CONDITION SUMMARY	5
LOAD RATING SUMMARY	7
INSPECTION NOTES	9
MAINTENANCE NEEDS	10
REPAIR COST ESTIMATE	11
STRUCTURE LIFE CYCLE ESTIMATE	12
PHOTOGRAPHS	13
CONDITION SUMMARY FIELD NOTES	28
GENERAL CODES	35
APPENDIX A - LOAD RATING CALCULATIONS	36

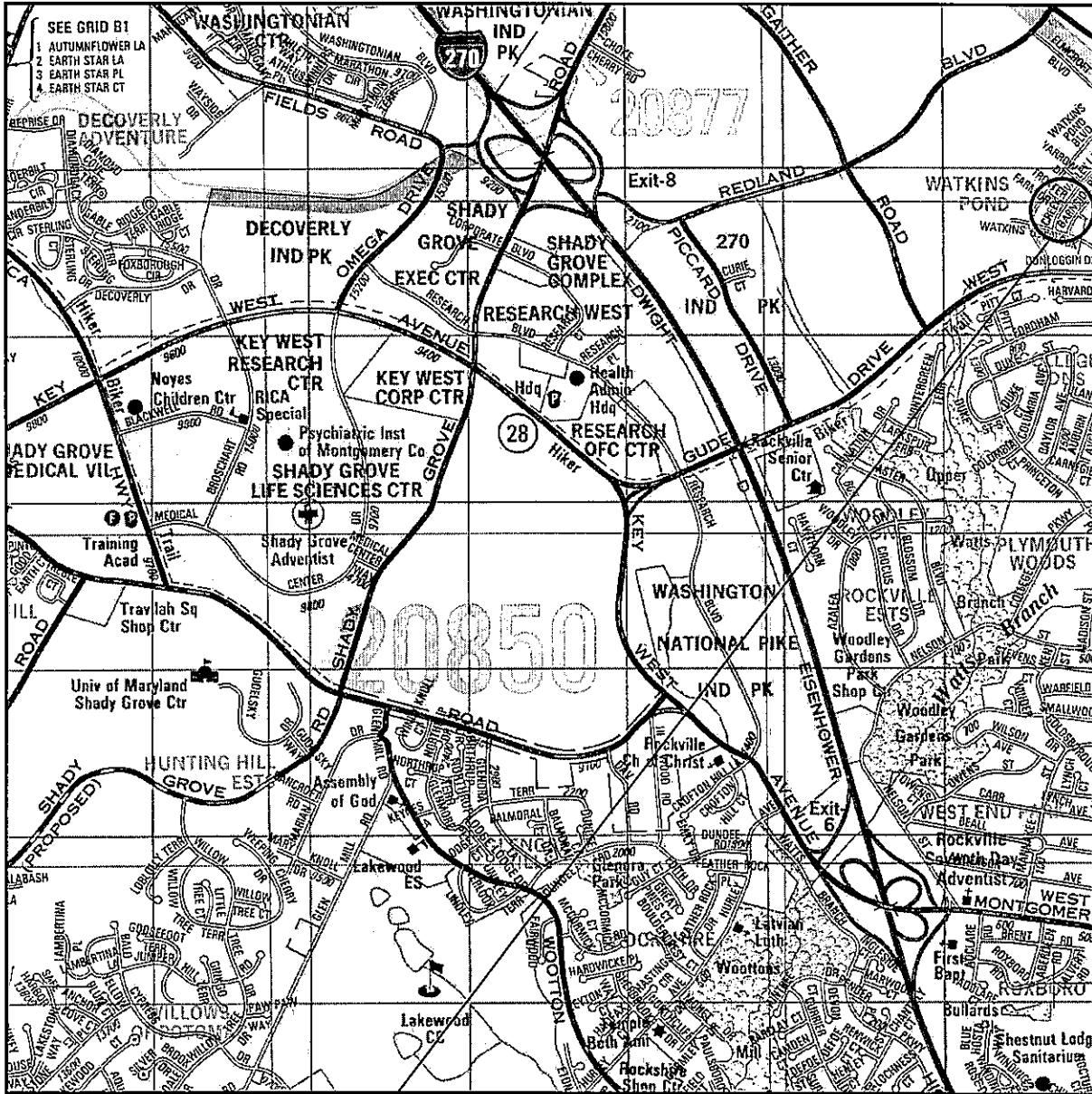
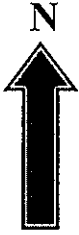

Structure No. PB-050
King Farm Park
Pedestrian Bridge over
Tributary to Watts Branch

Permitted Use Number 21002203
ADC Street Atlas Grid Location: 28-K2
Map Copyright © Universal Map Group LLC, (800) 829-6277

LOCATION MAP

SCALE: 1" = 2000'

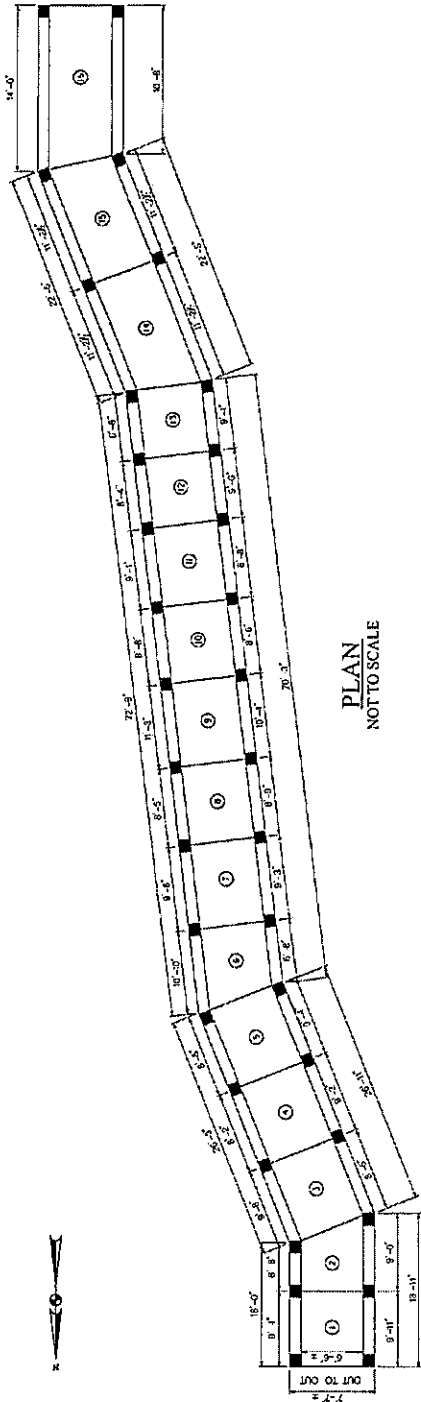

PLAN
NOT TO SCALE

SCHEDULE OF MEMBER SIZES	
TIMBER PLANK	1 1/2" x 6"
TIMBER BEAMS	2 1/2" x 10"
TIMBER PILE CAP	2 1/2" x 10"
TIMBER PILE	12" x 12" x 10'
TIMBER RAIL POST	2 1/2" x 4"
PRESSURE TREATED END RAIL FENCE	2" x 4" x 7.5'

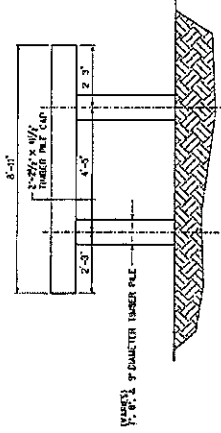

SECTION C-C TYPICAL PILE BENT
NOT TO SCALE

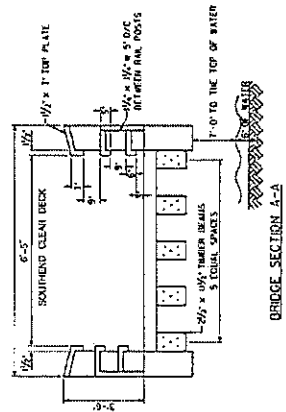

BRIDGE SECTION A-A
NOT TO SCALE

CITY OF ROCKVILLE
BRIDGE SKETCHES
KING FARM PARK PEDESTRIAN BRIDGE
OVER
TRIBUTARY TO WATTS BRANCH

2018 BRIDGE INSPECTION REPORT

BRIDGE DESCRIPTION SUMMARY

Roadway	King Farm Park
Bridge Orientation	North-South
Crossing	Tributary to Watts Branch
Crossing Orientation	East-West
Inspection Date	08/22/2018
Inspected By	EBA Engineering, Inc.
Spans	16
Type	Timber Beam Bridge
Structure Organization	Longitudinal Beams are numbered from the east; Pile Bents are numbered from the north.
Deck	1 1/2" x 5 1/2" Composite Planks (Plastic Lumber)
Railing	Timber and Composite Lumber
Abutments	Concrete
Wing Walls	Concrete
Piers	Timber Pile Bents
Overall Length	148'-6"±
Clear Roadway	6'-8"±
No. of Lanes	None
Out-to-Out Width	7'-7"±
Year Built	2008
Year Reconstructed	N/A
Approach Section	10'-0"± wide Walkway
Shoulders	None
Alignment	N/A
Profile	Level
Guardrail	None
Current Postings	The structure is load rated for pedestrian use and can sustain a uniform loading of 144 psf.
Overall Condition	Good
Remarks	

2018 BRIDGE INSPECTION REPORT

COMPARATIVE EVALUATION SUMMARY TABLE

<u>PONTIS ELEMENT</u>	<u>STATUS</u>	<u>CONDITION</u>	<u>REMARKS</u>
Approach Walkways	↔	Good	Both the North and South Approach transitions are settled up to 1 1/2" creating potential tripping hazards.
Deck	↔	Good	
Superstructure	↔	Good	
Substructure	↔	Good	10' long section of erosion around the pier between spans 9 and 10.
Channel	↔	Good	
Overall	↔	Good	



= Condition Improved



= Condition Unchanged



= Condition Worse

2018 BRIDGE INSPECTION REPORT

CONDITION SUMMARY

Approach Walkways

The approach concrete/brick walkways are in good condition (see Photographs 3 and 4). There are several minor cracks and spalls in both approach walkways. Typically, the minor spalls range from 3 square inches to up to 16 square inches with up to a 3/8" depth. At the North Approach Sidewalk, there is a 3'-10" long x 1/8" open crack (see Photograph 7). Since the last 2013 Bridge Inspection Report, the ADA pad at the North Approach was replaced. At the east and west side of the North Approach sidewalk, there are full-width cracks with minor spalls emanating (see Photographs 8 and 9). Both the North and South Approach transitions are settled up to 1 1/2" creating potential tripping hazards (see Photographs 10 and 11).

Deck

The composite lumber deck is typically in good condition. The timber deck and timber railing have been lined with composite materials and they are in good condition (see Photographs 12-15). Typically, there are gaps up to 1" open at the top corner of the railings (see Photograph 16). The timber railing posts exhibit typical checking and splintering at the south end of the east railing corner of the bridge. The 9th Post from the south end of the east railing exhibits up to a 1 1/2" open split approximately 14" long (see Photograph 17). There is a loose baluster at the east railing, 10th Post from the south end of the east railing (see Photograph 18). The base rail at the 7th post from north end of the east railing is broken and missing a 1'-8" long section (see Photograph 19). Both railings are crooked. Ice pick penetration in the timber railings is up to 3/4"±. There is minor algae growth throughout the structure. There is minor debris on the topside of the structure, especially at the south end. The underside of the deck is in good condition (see Photograph 20).

AASHTO requires that pedestrian bridge railings have a minimum height above the deck of 3'-6" and do not allow an 6" sphere to pass through the railing openings at any location. This railing system meets both criteria.

Superstructure

The timber beams are in good condition (see Photograph 20). There is a 3'-0" long x 1/4" open splinter in the fascia board at the west side of span 14 (see Photograph 21). Typically, the 7" high x 3/4" thick and 6" high x 2" thick fascia boards, there are up to 1/4" pick penetration. At the east side of Span 15, there is an approximately 4" diameter tree growing from the underside (see Photograph 22). At the west side of Span 12, the fascia board is misaligned approximately 3/16" out. Both timber fasciae exhibit typical checking, deterioration, and splitting.

The bearing areas at the bottom of the timber beams and at the top of the pile cap are generally in good condition.

Substructure

The faces of both abutments are covered with planks, so they could not be inspected. However, the visible portions appear to be in good condition (see Photographs 23 and 24). There are hairline cracks with efflorescence at the top of both abutment backwalls (see Photographs 10 and 11). The wing walls are in good condition. There is vegetation growth and minor debris around the wing wall (see Photograph 25).

The timber piles, pile caps, and diaphragms are in good condition. Typically, there is checking of the timber piles, pile caps, and diaphragms (see Photographs 26 and 27). There are two rot sections approximately 3" high x 2" wide x up to 3/4" of pick penetration in the west Pile at Bent 10 (see Photographs 28 and 29). Also, there is a 10' long section of erosion around this pier between spans 9 and 10 (see Photograph 30).

2018 BRIDGE INSPECTION REPORT

CONDITION SUMMARY

Channel

The channel is in good condition. The stream flows from east to west. The stream banks are well vegetated.

Overall

Bridge No. PB-050 was inspected by EBA Engineering, Inc. on August 22, 2013 and October 5, 2018. The structure is in overall good condition.

The numbering convention for reporting purpose is from north and east. The longitudinal beams are numbered from the east and the Pile Bents are numbered from the north.

City of Rockville Load Rating Summary Sheet

Bridge No.: PB-050 on King Farm Park over Tributary to Watts Branch

Date of Rating: 10/11/2018 LARS Program: Yes No Program Used: Hand Calculations (Spreadsheet)

Rating Method: LRFR LFR ASR Engineering Judgment Load Testing HMA Wearing Surface? N/A

Rating Type: As-Built As Inspected Condition Report Date: 8/22/2018

Deterioration Reduced Capacity: No/Negligible Section Loss Reduced Section Used for Rating

*All legal and permit vehicles must be completed, regardless of the rating method. The HL-93 is only rated for LRFR.

**For LRFR there is no Inventory Rating for Legal and Permit Loads. Enter the Operating Limit State in the Inventory column for Legal Loads, set Inventory to zero for Permit Loads.

*LRFR Design/Load Rating Vehicle (Limit States are Strength I for all materials, Service II for Steel only, or Service III for prestressed concrete inventory only)

Truck/ Axle/ Tons	Rating Details	Inventory	Operating
	Controlling Member	Limit State	Limit State
	Controlling Stress (Moment, Shear, Service)	Rating Factor	Rating Factor
HL-93/3/36 Tons	enter controlling member (i.e. Sp. 1, Ext. Beam)	Limit State	Limit State
	Select the Controlling Stress	0	0

MD Legal Loads (For LRFR the Limit States are Strength I for all materials or Service II for steel only)			
Truck/Axles/Tons	Controlling Member	**Inventory or Limit State	Operating
	Controlling Stress (Moment, Shear, Service)	Tons (XX.X)	Tons (XX.X)
H-15 / 2 / 15	Timber Beam Superstructure	N/A	N/A
	Moment		
T-3 / 3 / 33	Timber Beam Superstructure	N/A	N/A
	Moment		
T-4 / 4 / 35	Timber Beam Superstructure	N/A	N/A
	Moment		
HS-20 / 3 / 36	Timber Beam Superstructure	N/A	N/A
	Moment		
3S2 / 5 / 40	Timber Beam Superstructure	N/A	N/A
	Moment		

If rating in LRFR, enter Oper. Limit State.

Pedestrian / Trail Structure Typical Loads (if applicable based on access / deck width)			
Type/Axles/Pounds	Controlling Member	**Inventory	Operating
	Controlling Stress (Moment, Shear, Service)	Pounds (X,XXX)	Pounds (X,XXX)
Point Load/1/Max	Timber Deck Planks	267	267
	Moment		
Pedestrian /s.f./ 85 psf or 90 psf *	Timber Beam Superstructure	144	144
	Moment		
H-5 / 2 / 10,000	Timber Beam Superstructure	N/A	N/A
	Moment		
H-10 / 2 / 20,000	Timber Beam Superstructure	N/A	N/A
	Moment		
Golf Cart / 2 / 2,000	Timber Deck Planks	1,795	1,795
	Moment		
Utility / 2 / 3,000	Timber Deck Planks	807	807
	Moment		

Enter Pedestrian / Trail Loading Values in pounds

* Pedestrian Load Note: The Design Load using LFD or ASD methods is 85 psf; design load using LRFD method is 90 psf.

City of Rockville Load Rating Summary Sheet (continued)

LOAD POSTING RECOMMENDED: Yes No *Not applicable for Pedestrian Bridge*
Single Unit Truck: lbs. Combination Truck: lbs.

Bridge Information Used: None, Field Measurements Previous Load Rate Calcs Drawings

Drawing and/or Previous Rating Details: No construction drawings were available or provided to indicate the dimensions, details, and material specifications for the structure. The structure was not previously load rated. This load rating analysis is based on approximate field measurements and guidance from AASHTO's Manual for Bridge Evaluation (MBE) regarding material property assumptions to use when specific information is not available.

Comments/Defects/Assumptions: Bridge No. PB-050 consists of a 16-span timber bridge with a composite lumber plank deck bearing on timber stringers supported by timber pier caps bearing on round timber piles. The timber beam superstructure consists of seven 2x12 timber stringers.

As material type and properties were not available for the load rating of this timber structure, it was assumed that the bridge superstructure is built of Select Structural Grade Spruce-Pine-Fir. This is a reasonable assumption for a structure located in Maryland. The composite lumber deck bending and shear strengths were taken from specifications for Trex decking system. In our analysis, the base bending and shear strengths for these materials were multiplied by several modifying factors to account for the specific conditions and configuration of this structure. Where specific information was not available (such as the moisture content of the timber), the lowest reasonable value of the modifying factor was selected. Due to the conservative nature of this approach, it is possible that the capacity of the structure has been underestimated in this analysis. However, detailed material data would be required to refine these assumptions.

The clear space between the timber railings for this bridge is 6'-6 1/2". Therefore, the bridge does not accommodate any Maryland legal trucks. Therefore, the structure was rated for a maximum point load placed at the center of the longest span, a distributed pedestrian load, a golf cart, and a utility vehicle.

During the 2018 Bridge Inspection, the structure was observed to be in good condition (SI&A Item 59 = 7) with no signs of structural distress due to loading.

This load rating was developed in accordance with recommendations and guidance found in AASHTO's Manual for Bridge Evaluation (MBE).

2018 BRIDGE INSPECTION REPORT

BRIDGE INSPECTION NOTES

VISUAL INSPECTION NOTE

The condition ratings and evaluations presented herein are based upon visual inspection of accessible portions of the existing structure. No responsibility is assumed by EBA Engineering, Inc. for the presence of any latent structure defects which cannot be detected by such visual inspection.

BRIDGE SKETCHES NOTE

The bridge sketches included in this report were previously prepared by others and are reproduced herein from materials furnished by the City of Rockville. No responsibility is assumed by EBA Engineering, Inc. for the accuracy of the sketches and the correctness of any detail dimensions.

INSPECTION ACCESS NOTE

Waders were used to access Bridge No. PB-050.

CITY OF ROCKVILLE
Department of Public Works
Parks and Facilities Division

BRIDGE NO. PB-050 - King Farm Park OVER Tributary to Watts Branch



1. East Elevation



2. West Elevation

CITY OF ROCKVILLE
Department of Public Works
Parks and Facilities Division

BRIDGE NO. PB-050 - King Farm Park OVER Tributary to Watts Branch

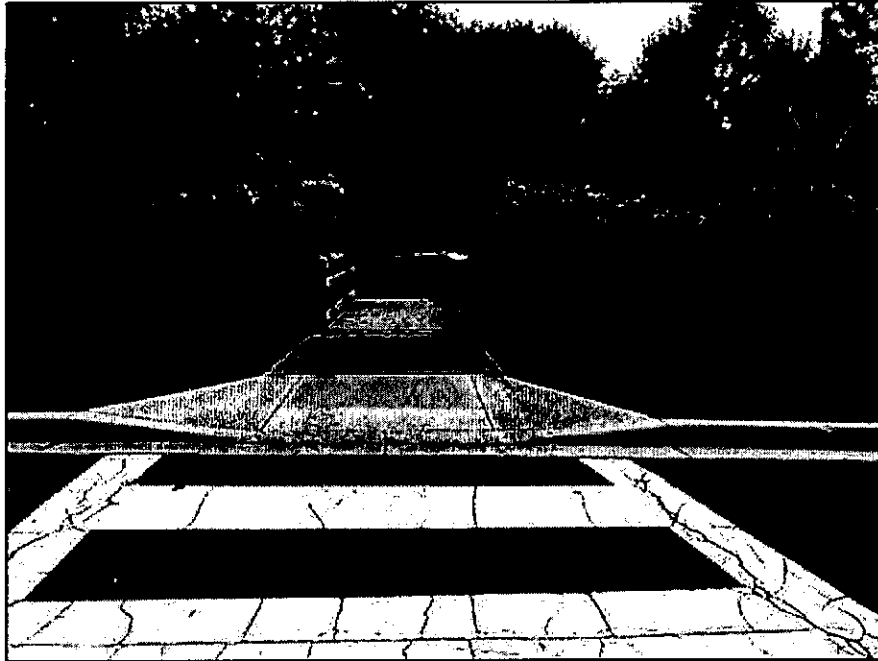

3. North Approach Looking South



4. South Approach Looking North

CITY OF ROCKVILLE
Department of Public Works
Parks and Facilities Division

BRIDGE NO. PB-050 - King Farm Park OVER Tributary to Watts Branch



5. Upstream (Looking East)



6. Downstream (Looking West)

CITY OF ROCKVILLE
Department of Public Works
Parks and Facilities Division

BRIDGE NO. PB-050 - King Farm Park OVER Tributary to Watts Branch

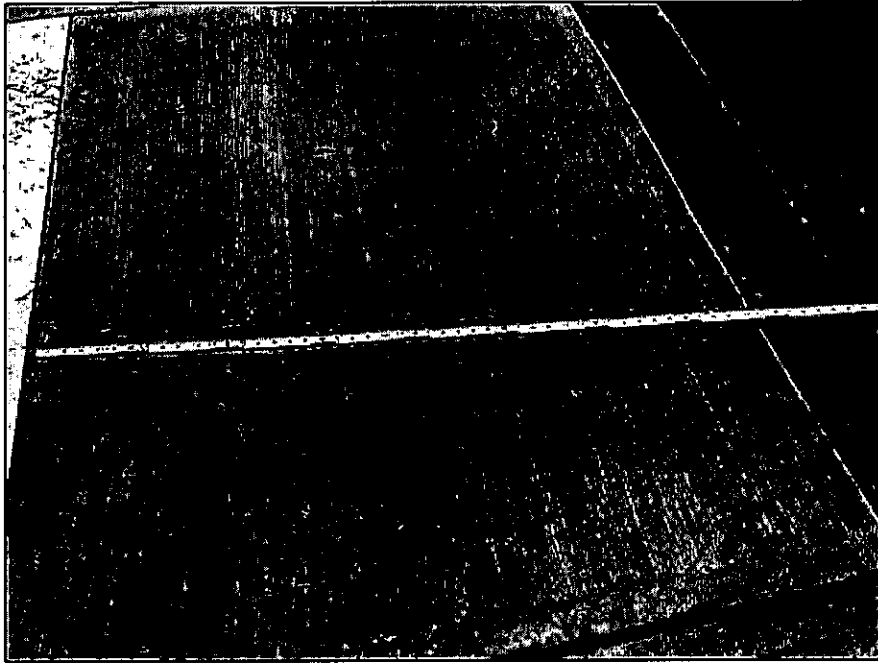

7. Approximately 3'-10" Long x 1/8" Open Crack in Concrete Sidewalk

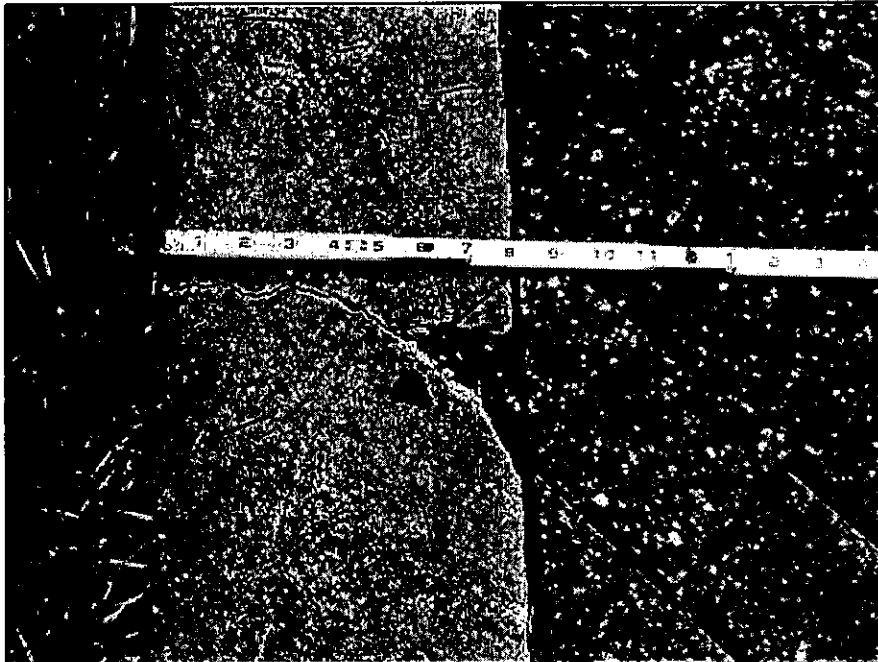

8. Hairline Cracking in the North Approach at the East Side

CITY OF ROCKVILLE
Department of Public Works
Parks and Facilities Division

BRIDGE NO. PB-050 - King Farm Park OVER Tributary to Watts Branch

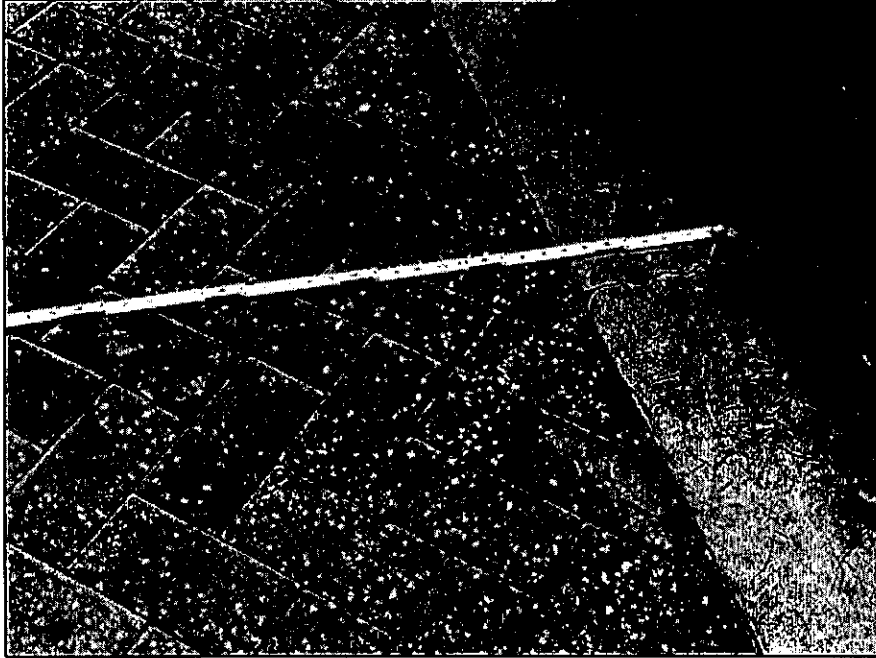

9. Hairline cracking in the North Approach at the West Side



10. Up to 1 1/2" Settlement at the North Approach Concrete Backwall; Possible Trip Hazard

CITY OF ROCKVILLE
Department of Public Works
Parks and Facilities Division

BRIDGE NO. PB-050 - King Farm Park OVER Tributary to Watts Branch

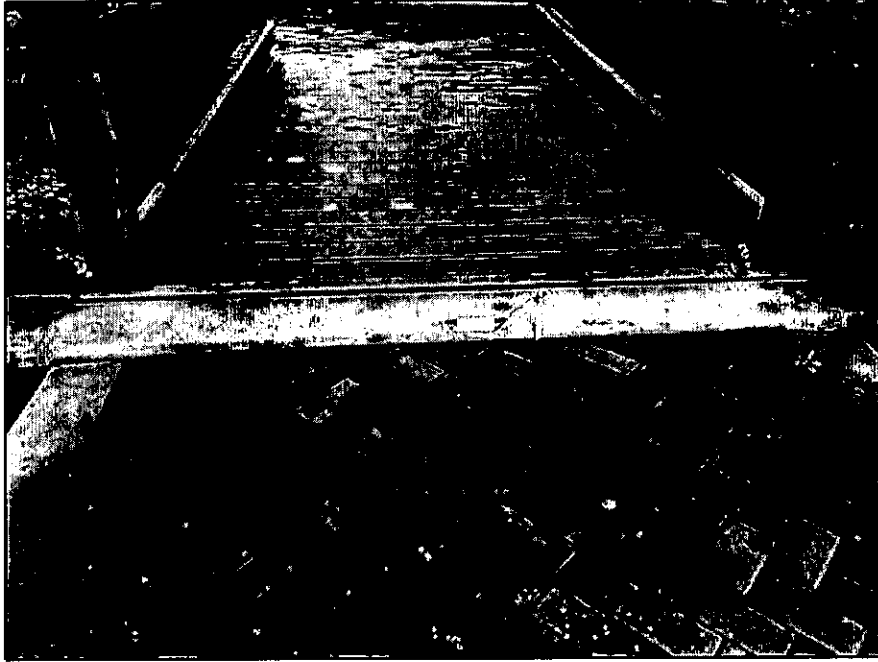

11. South Approach Walkway Transition Approximately 1 1/2" settled from Concrete Backwall



12. Main Span View of Deck Looking South

CITY OF ROCKVILLE
Department of Public Works
Parks and Facilities Division

BRIDGE NO. PB-050 - King Farm Park OVER Tributary to Watts Branch



13. General Deck View Looking North

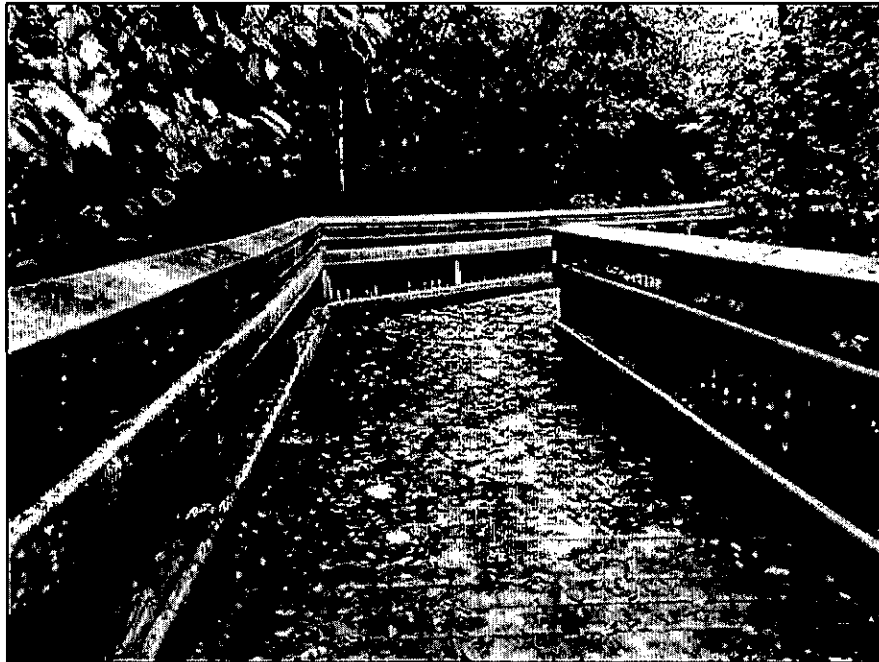

14. General View of Deck at the South end

CITY OF ROCKVILLE
Department of Public Works
Parks and Facilities Division

BRIDGE NO. PB-050 - King Farm Park OVER Tributary to Watts Branch



15. Typical View of Railings

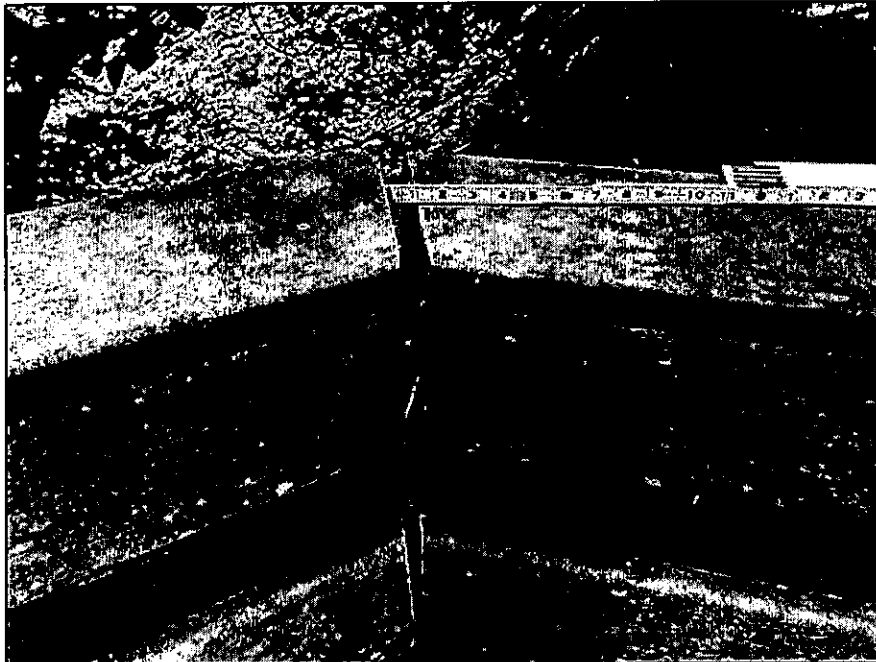

16. Typical Top Railing Gap Approximately 1" Separated

CITY OF ROCKVILLE
Department of Public Works
Parks and Facilities Division

BRIDGE NO. PB-050 - King Farm Park OVER Tributary to Watts Branch



17. Up to 1 1/2" Open Split in 9th Wood Post from the South End of the East Railing



18. Loose Balustrade Adjacent to 10th Post from the South End of East Railing

CITY OF ROCKVILLE
Department of Public Works
Parks and Facilities Division

BRIDGE NO. PB-050 - King Farm Park OVER Tributary to Watts Branch



19. Broken Base Rail at 7th Post from North End of East Railing



20. Typical View of Underside

CITY OF ROCKVILLE
Department of Public Works
Parks and Facilities Division

BRIDGE NO. PB-050 - King Farm Park OVER Tributary to Watts Branch

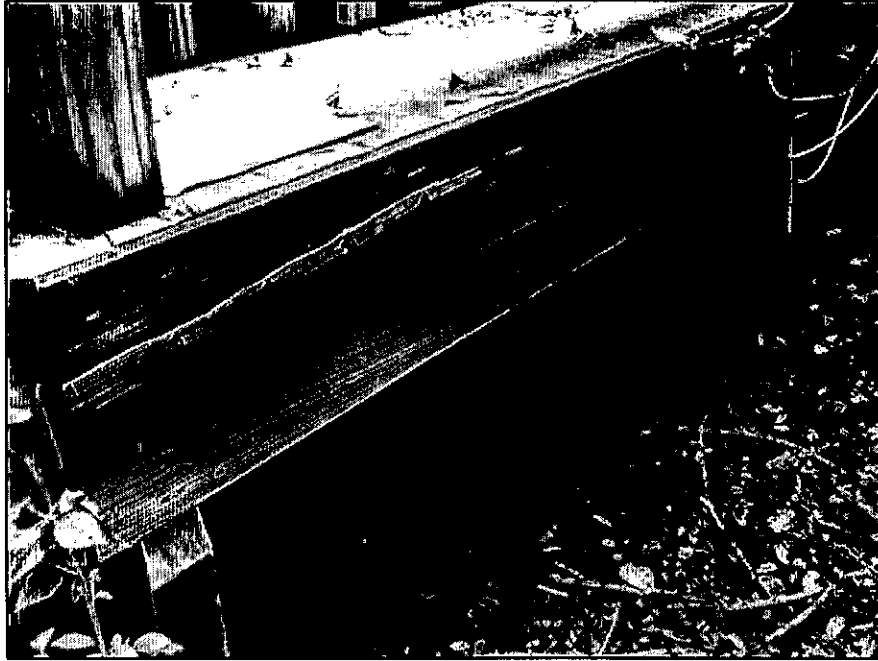

21. 3'-0" Long x 1/4" Open Splintering in Fascia Board at the West Side of Span 14



22. Approximately 4" Diameter Tree Growing under East Side of Span 15

CITY OF ROCKVILLE
Department of Public Works
Parks and Facilities Division

BRIDGE NO. PB-050 - King Farm Park OVER Tributary to Watts Branch



23. Overall View of North Abutment



24. South Abutment View From East

CITY OF ROCKVILLE
Department of Public Works
Parks and Facilities Division

BRIDGE NO. PB-050 - King Farm Park OVER Tributary to Watts Branch



25. Typical View of Wing Wall (Southwest Wing Wall Shown)



26. Typical View of Piles

CITY OF ROCKVILLE
Department of Public Works
Parks and Facilities Division

BRIDGE NO. PB-050 - King Farm Park OVER Tributary to Watts Branch



27. Typical Checks in Top of Timber Pile Caps (Bent 13 Shown)



28. Approximately 3" High x 2" Wide x Up to 3/4" Pick Penetration Rot in west Pile at Bent 10

CITY OF ROCKVILLE
Department of Public Works
Parks and Facilities Division

BRIDGE NO. PB-050 - King Farm Park OVER Tributary to Watts Branch



29. Approximately 3" High x 2" Wide x Up to 3/4" Pick Penetration Rot in west Pile at Bent 10



30. Erosion in Span 9 and 10 Leading to Channel Up to 10 Feet Long

2018 BRIDGE INSPECTION REPORT

Bridge No. PB-050 **Inspection Crew** JE/JC/JD **Date** 08/22/2018
Name King Farm Park **Crossing** Tributary to Watts Branch
Bridge Type Timber Beam Bridge **Year Built** 2008

58 DECK	CONDITION RATING	
1. Wearing Surface (302)	-	
2. Deck - Topside (301)	7	Composite Lumber
3. Deck - Underside (301)	7	
4. Curbs (304)	-	
5. Median (304)	-	
6. Sidewalks (304)	-	
7. Parapets (303)	-	
8. Railing (303)	7	Timber and Composite Lumber
9. Roadway Joints	-	
10. Drainage System (314)	-	
11. Lighting Standards	-	
12. Utilities	-	
13. Other	-	
Inspector's Condition Rating (58)		7

The composite lumber deck is typically in good condition. The timber deck and timber railing have been lined with composite materials and they are in good condition. There is minor algae growth throughout the structure. There is minor debris on the topside of the structure, especially at the south end. The underside of the deck is in good condition.

58.8 Typically, there are gaps up to 1" open at the top corner of the railings. The timber railing posts exhibit typical checking and splintering at the south end of the east railing corner of the bridge. The 9th Post from the south end of the east railing exhibits up to a 1 1/2" open split approximately 14" long. There is a loose baluster at the east railing, 10th Post from the south end of the east railing. The base rail at the 7th post from north end of the east railing is broken and missing a 1'-8" long section. Both railings are crooked. Ice pick penetration in the timber railings is up to 3/4"±.

2018 BRIDGE INSPECTION REPORT

Bridge No. PB-050 **Inspection Crew** JE/JC/JD **Date** 08/22/2018
Name King Farm Park **Crossing** Tributary to Watts Branch
Bridge Type Timber Beam Bridge **Year Built** 2008

59 SUPERSTRUCTURE

Number of Spans 16
 Type of Construction Timber Bridge

	CONDITION RATING	
1. Bearing Devices (311)	<input style="width: 50px; height: 20px;" type="text" value="-"/>	
2. Girders or Beams (312)	<input style="width: 50px; height: 20px;" type="text" value="7"/>	Timber
3. Stringers (312)	<input style="width: 50px; height: 20px;" type="text" value="-"/>	
4. Floor Beams (312)	<input style="width: 50px; height: 20px;" type="text" value="-"/>	
5. Diaphragms/Crossframes	<input style="width: 50px; height: 20px;" type="text" value="7"/>	Timber
6. Paint (313)	<input style="width: 50px; height: 20px;" type="text" value="-"/>	
7. Other	<input style="width: 50px; height: 20px;" type="text" value="-"/>	
8. Rivets or Bolts	<input style="width: 50px; height: 20px;" type="text" value="7"/>	
9. Welds - Cracks	<input style="width: 50px; height: 20px;" type="text" value="-"/>	
10. Rust	<input style="width: 50px; height: 20px;" type="text" value="-"/>	
11. Timber Decay	<input style="width: 50px; height: 20px;" type="text" value="7"/>	
12. Concrete Cracking	<input style="width: 50px; height: 20px;" type="text" value="-"/>	
13. Collision Damage	<input style="width: 50px; height: 20px;" type="text" value="-"/>	
14. Deflection Under Load	<input style="width: 50px; height: 20px;" type="text" value="7"/>	
15. Alignment of Members	<input style="width: 50px; height: 20px;" type="text" value="7"/>	
16. Vibrations Under Load	<input style="width: 50px; height: 20px;" type="text" value="7"/>	
17. Fracture Critical Members (325)	<input style="width: 50px; height: 20px;" type="text" value="-"/>	

Inspector's Condition Rating (59)

The timber beams are in good condition. There is a 3'-0" long x 1/4" open splinter in the fascia board at the west side of span 14. Typically, the 7" high x 3/4" thick and 6" high x 2" thick fascia boards, there are up to 1/4" pick penetration. At the east side of Span 15, there is an approximately 4" diameter tree growing from the underside. At the west side of Span 12, the fascia board is misaligned approximately 3/16" out. Both timber fasciae exhibit typical checking, deterioration, and splitting.

59.1 The bearing areas at the bottom of the timber beams and at the top of the pile cap are generally in good condition.

2018 BRIDGE INSPECTION REPORT

Bridge No. PB-050 Inspection Crew JE/JC/JD Date 08/22/2018
 Name King Farm Park Crossing Tributary to Watts Branch
 Bridge Type Timber Beam Bridge Year Built 2008

60 SUBSTRUCTURE

CONDITION RATING

1. Abutments	-Wingwalls	<input style="width: 80px; height: 20px;" type="text" value="7"/>	
	-Backwalls	<input style="width: 80px; height: 20px;" type="text" value="7"/>	
	-Stems	<input style="width: 80px; height: 20px;" type="text" value="7"/>	
	-Footings	<input style="width: 80px; height: 20px;" type="text" value="-"/>	Not Visible
	-Piles	<input style="width: 80px; height: 20px;" type="text" value="-"/>	Not Visible
	-Scour/Erosion	<input style="width: 80px; height: 20px;" type="text" value="7"/>	
	-Settlement	<input style="width: 80px; height: 20px;" type="text" value="7"/>	
	Overall Abutment Rating (322)	<input style="width: 80px; height: 20px;" type="text" value="7"/>	Abutment Type <u>Concrete</u>
2. Piers or Bents	-Caps	<input style="width: 80px; height: 20px;" type="text" value="-"/>	
	-Columns	<input style="width: 80px; height: 20px;" type="text" value="-"/>	
	-Footings	<input style="width: 80px; height: 20px;" type="text" value="-"/>	
	-Piles	<input style="width: 80px; height: 20px;" type="text" value="-"/>	
	-Scour/Erosion	<input style="width: 80px; height: 20px;" type="text" value="-"/>	
	-Settlement	<input style="width: 80px; height: 20px;" type="text" value="-"/>	
	Overall Pier Rating	<input style="width: 80px; height: 20px;" type="text" value="7"/>	Pier Type <u>Timber</u>
3. Pile Bents	-Caps	<input style="width: 80px; height: 20px;" type="text" value="7"/>	
	-Piles (324)	<input style="width: 80px; height: 20px;" type="text" value="7"/>	
4. Concrete Cracking or Spalling		<input style="width: 80px; height: 20px;" type="text" value="-"/>	
5. Steel Corrosion		<input style="width: 80px; height: 20px;" type="text" value="-"/>	
6. Timber Decay		<input style="width: 80px; height: 20px;" type="text" value="7"/>	
7. Other		<input style="width: 80px; height: 20px;" type="text" value="-"/>	
8. Debris on Seats		<input style="width: 80px; height: 20px;" type="text" value="8"/>	
9. Paint		<input style="width: 80px; height: 20px;" type="text" value="-"/>	
10. Collision Damage		<input style="width: 80px; height: 20px;" type="text" value="7"/>	
11. Overall Undermining/Scour		<input style="width: 80px; height: 20px;" type="text" value="7"/>	

Inspector's Condition Rating (60)

The faces of both abutments are covered with planks, so they could not be inspected. However, the visible portions appear to be in good condition.

60.1 There are hairline cracks with efflorescence at the top of both abutment backwalls. The wing

2018 BRIDGE INSPECTION REPORT

Bridge No. PB-050 **Inspection Crew** JE/JC/JD **Date** 08/22/2018
Name King Farm Park **Crossing** Tributary to Watts Branch
Bridge Type Timber Beam Bridge **Year Built** 2008

walls are in good condition. There is vegetation growth and minor debris around the wing wall.

60.2 The timber piles, pile caps, and diaphragms are in good condition. Typically, there is checking of the timber piles, pile caps, and diaphragms. There are two rot sections approximately 3" high x 2" wide x up to 3/4" of pick penetration in the west Pile at Bent 10. Also, there is a 10' long section of erosion around this pier between spans 9 and 10.

2018 BRIDGE INSPECTION REPORT

Bridge No. PB-050 Inspection Crew JE/JC/JD Date 08/22/2018
Name King Farm Park Crossing Tributary to Watts Branch
Bridge Type Timber Beam Bridge Year Built 2008

61 CHANNEL AND CHANNEL PROTECTION

	CONDITION RATING	
1. Channel Scour	<input style="width: 50px; height: 20px;" type="text" value="7"/>	
2. Embankment Erosion	<input style="width: 50px; height: 20px;" type="text" value="7"/>	
3. Drift/Debris	<input style="width: 50px; height: 20px;" type="text" value="7"/>	
4. Vegetation	<input style="width: 50px; height: 20px;" type="text" value="7"/>	
5. Channel Alignment	<input style="width: 50px; height: 20px;" type="text" value="7"/>	
6. Fender System	<input style="width: 50px; height: 20px;" type="text" value="-"/>	
7. Spur Dikes and Jetties	<input style="width: 50px; height: 20px;" type="text" value="-"/>	
8. Riprap/Slope Protection	<input style="width: 50px; height: 20px;" type="text" value="-"/>	None

Inspector's Condition Rating (61)

The channel is in good condition. The stream flows from east to west. The stream banks are well vegetated.

2018 BRIDGE INSPECTION REPORT

Bridge No. PB-050 Inspection Crew JE/JC/JD Date 08/22/2018
Name King Farm Park Crossing Tributary to Watts Branch
Bridge Type Timber Beam Bridge Year Built 2008

71 WATERWAY ADEQUACY

Opening	Good	<input type="text" value="Fair"/>	Poor	
Alignment	<input type="text" value="Good"/>	Fair	Poor	
Frequency of Overtopping	<input type="text" value="Remote"/>	Slight	Occasional	Frequent

Inspector's Condition Rating (71)

General Rating Codes

Condition ratings have been assigned to each of the structural elements based on the NBIS condition rating system as follows:

- 9 – Excellent Condition
- 8 – Very Good Condition – No problems noted.
- 7 – Good Condition – Some minor problems.
- 6 – Satisfactory Condition – Structural elements show some very minor deterioration.
- 5 – Fair Condition – All primary structural elements are sound, but may have minor deterioration.
- 4 – Poor Condition – Advanced section loss, deterioration, spalling or scour.
- 3 – Serious Condition – Loss of section, deterioration, spalling or scour have seriously affected the primary structural components.
- 2 – Critical Condition – Advanced deterioration of primary structural elements. Unless closely monitored it may be necessary to close the bridge until corrective action is taken.
- 1 – “Imminent” Failure Condition – Major deterioration or section loss present in critical structural components or obvious vertical or horizontal movement affecting the structure stability. Bridge is closed to traffic, but corrective action may put back in light service.
- 0 – Failed Condition – Out of service – beyond corrective action.
- N – Not Applicable

Repair Time Frames

Priority Level	Time Frame
Critical (1)	Within 3 months
High (2)	Within 12 months
Medium (3)	Within 1-2 years
Monitor/Re-evaluation (4)	Assess during next inspection

Appendix A - Load Rating Calculations

CITY OF ROCKVILLE
Department of Public Works
Parks and Facilities Division



2018 ***Load Rating Report***

BRIDGE NO. PB-050
King Farm Park
OVER
Tributary to Watts Branch



EBA Engineering Inc.
4813 Seton Drive
Baltimore, MD 21215

o 410.358.7171
f 410.358.7213
w www.ebaengineering.com



CITY OF ROCKVILLE
Department of Public Works
Parks and Facilities Division

2018 BRIDGE LOAD RATING ANALYSIS REPORT

Bridge No. PB-050

King Farm Park over Tributary to Watts Branch

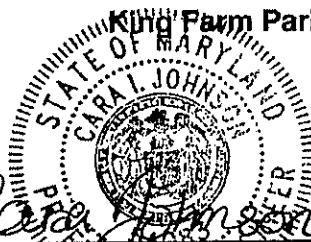
Cara L. Johnson
 Cara L. Johnson, P.E.
 (Load Rating Engineer)

11/2/2018
Date

Professional Certification: I hereby certify that these documents were prepared or approved by me, and that I am a duly licensed professional engineer under the laws of the State of Maryland.

License No. 51083
 Expiration Date: 6/7/2019

Load Rating Note:

This Live Load Rating Report was prepared under my supervision. The analysis was performed on main structural members of the bridge's superstructure or culvert's barrel only. The condition data, calculations, and analysis contained within this report are based on information contained within the most recent Bridge Inspection Report, which is based on a visual inspection of accessible portions of the structure. Structure details and dimensions were obtained from construction drawings and/or previous Load Rating Reports when available and provided by the City; if this information was not available, the bridge details and dimensions are based on approximate field measurements. No responsibility is accepted for the existence of latent defects which cannot be detected during visual inspection. The structure must be re-analyzed and the load rating values revised should the condition of the structure deteriorate or the anticipated loads on the structure change.

Load Rating Engineer: Cara Johnson 11/2/18
 Cara Johnson, P.E. Date

QC Engineer: Jennifer Callaghan 11/02/2018
 Jennifer Callaghan, P.E. Date



EBA Engineering, Inc.
 4813 Seton Drive
 Baltimore, MD 21215

☎ 410.358.7171
 ☎ 410.358.7213
 🌐 www.ebaengineering.com

City of Rockville Load Rating Summary Sheet

Bridge No.: PB-050 on King Farm Park over Tributary to Watts Branch

Date of Rating: 10/11/2018 LARS Program: Yes No Program Used: Hand Calculations (Spreadsheet)

Rating Method: LRFR LFR ASR Engineering Judgment Load Testing HMA Wearing Surface? N/A

Rating Type: As-Built As Inspected Condition Report Date: 8/22/2018

Deterioration Reduced Capacity: No/Negligible Section Loss Reduced Section Used for Rating

*All legal and permit vehicles must be completed, regardless of the rating method. The HL-93 is only rated for LRFR.

**For LRFR there is no Inventory Rating for Legal and Permit Loads. Enter the Operating Limit State in the Inventory column for Legal Loads, set Inventory to zero for Permit Loads.

***LRFR Design/Load Rating Vehicle (Limit States are Strength I for all materials, Service II for Steel only, or Service III for prestressed concrete Inventory only)**

Truck/ Axle/ Tons	Rating Details	Inventory	Operating
	Controlling Member	Limit State	Limit State
	Controlling Stress (Moment, Shear, Service)	Rating Factor	Rating Factor
HL-93/3/36 Tons	enter controlling member (i.e. Sp. 1, Ext. Beam)	Limit State	Limit State
	Select the Controlling Stress	0	0

MD Legal Loads (For LRFR the Limit States are Strength I for all materials or Service II for steel only)			
Truck/Axles/Tons	Controlling Member	**Inventory or Limit State	Operating
	Controlling Stress (Moment, Shear, Service)	Tons (XX.X)	Tons (XX.X)
H-15 / 2 / 15	Timber Beam Superstructure	N/A	N/A
	Moment		N/A
T-3 / 3 / 33	Timber Beam Superstructure	N/A	N/A
	Moment		N/A
T-4 / 4 / 35	Timber Beam Superstructure	N/A	N/A
	Moment		N/A
HS-20 / 3 / 36	Timber Beam Superstructure	N/A	N/A
	Moment		N/A
3S2 / 5 / 40	Timber Beam Superstructure	N/A	N/A
	Moment		N/A

If rating in LRFR, enter Oper. Limit State.

Pedestrian / Trail Structure Typical Loads (if applicable based on access / deck width)			
Type/Axles/Pounds	Controlling Member	**Inventory	Operating
	Controlling Stress (Moment, Shear, Service)	Pounds (X,XXX)	Pounds (X,XXX)
Point Load/1/Max	Timber Deck Planks	267	267
	Moment		
Pedestrian /s.f./ 85 psf or 90 psf *	Timber Beam Superstructure	144	144
	Moment		
H-5 / 2 / 10,000	Timber Beam Superstructure	N/A	N/A
	Moment		
H-10 / 2 / 20,000	Timber Beam Superstructure	N/A	N/A
	Moment		
Golf Cart / 2 / 2,000	Timber Deck Planks	1,795	1,795
	Moment		
Utility / 2 / 3,000	Timber Deck Planks	807	807
	Moment		

Enter Pedestrian / Trail Loading Values in pounds

* Pedestrian Load Note: The Design Load using LFD or ASD methods is 85 psf; design load using LRFD method is 90 psf.

City of Rockville Load Rating Summary Sheet (continued)

LOAD POSTING RECOMMENDED: Yes No *Not applicable for Pedestrian Bridge*
Single Unit Truck: lbs. Combination Truck: lbs.

Bridge Information Used: None, Field Measurements Previous Load Rate Calcs Drawings

Drawing and/or Previous Rating Details: No construction drawings were available or provided to indicate the dimensions, details, and material specifications for the structure. The structure was not previously load rated. This load rating analysis is based on approximate field measurements and guidance from AASHTO's Manual for Bridge Evaluation (MBE) regarding material property assumptions to use when specific information is not available.

Comments/Defects/Assumptions: Bridge No. PB-050 consists of a 16-span timber bridge with a composite lumber plank deck bearing on timber stringers supported by timber pier caps bearing on round timber piles. The timber beam superstructure consists of seven 2x12 timber stringers.

As material type and properties were not available for the load rating of this timber structure, it was assumed that the bridge superstructure is built of Select Structural Grade Spruce-Pine-Fir. This is a reasonable assumption for a structure located in Maryland. The composite lumber deck bending and shear strengths were taken from specifications for Trex decking system. In our analysis, the base bending and shear strengths for these materials were multiplied by several modifying factors to account for the specific conditions and configuration of this structure. Where specific information was not available (such as the moisture content of the timber), the lowest reasonable value of the modifying factor was selected. Due to the conservative nature of this approach, it is possible that the capacity of the structure has been underestimated in this analysis. However, detailed material data would be required to refine these assumptions.

The clear space between the timber railings for this bridge is 6'-6 1/2". Therefore, the bridge does not accommodate any Maryland legal trucks. Therefore, the structure was rated for a maximum point load placed at the center of the longest span, a distributed pedestrian load, a golf cart, and a utility vehicle.

During the 2018 Bridge Inspection, the structure was observed to be in good condition (SI&A Item 59 = 7) with no signs of structural distress due to loading.

This load rating was developed in accordance with recommendations and guidance found in AASHTO's Manual for Bridge Evaluation (MBE).

PEDESTRIAN / TRAIL STRUCTURE DESIGN LOADS

CHECK BOX IF
LOAD RATED



Point Load at Mid-span

Pedestrian Load

LRFR 90 psf

LFR 85 psf

ASR 85 psf

Apply Maximum Point Load at Mid-span (worst case)

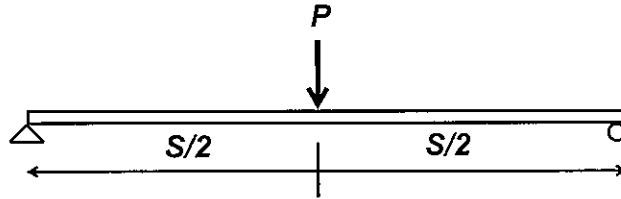

3.1—PEDESTRIAN LOADING (PL)

Pedestrian bridges shall be designed for a uniform pedestrian loading of 90 psf. This loading shall be patterned to produce the maximum load effects in accordance with *AASHTO LRFD* Article 3.4. Consideration of dynamic load allowance is not required with this loading.

LRFR use 90 psf
LFR use 85 psf
ASR use 85 psf

C3.1

The previous edition of these Guide Specifications used a base nominal loading of 85 psf, reducible to 65 psf based on influence area for the pedestrian load. With the LFD load factors, this results in factored loads of $2.17(85) = 184$ psf and $2.17(65) = 141$ psf. The Fourth Edition of *AASHTO LRFD* specified a constant 85 psf regardless of influence area. Multiplying by the load factor, this results in $1.75(85) = 149$ psf. This falls within the range of the previous factored loading, albeit toward the lower end.

If vehicles are not prevented (blocked) by physical methods, pedestrian bridges shall be designed for a maintenance vehicle load specified in Figure 1 and Table 1 for the Strength I Load Combination unless otherwise specified by the Owner. A single truck shall be placed to produce the maximum load effects and shall not be placed in combinations with the pedestrian load. The dynamic load allowance need not be considered for this loading.

Deck clear width 7 to 10 feet?

H-5 MAINTENANCE TRUCK
(AASHTO 5 Tons = 10 KIPS)

Table 3.2-1—Design Vehicle

Clear Deck With	Design Vehicle
7 to 10 feet	H5
Over 10 feet	H10

Deck clear width over 10 feet?

H-10 MAINTENANCE TRUCK
(AASHTO 10 Tons = 20 KIPS)

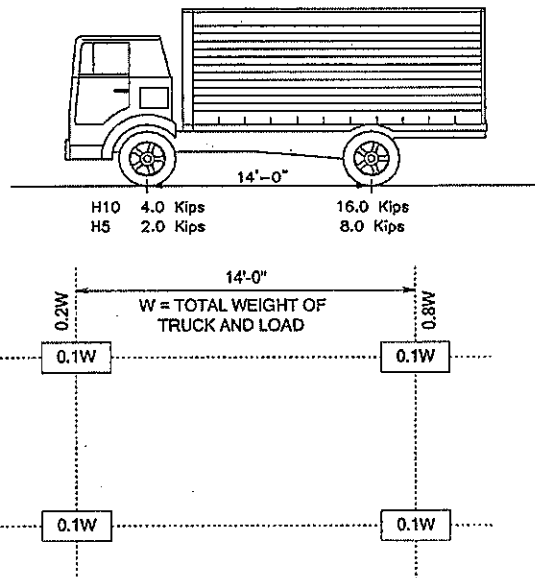

Figure 3.2-1—Maintenance Vehicle Configurations.

PEDESTRIAN / TRAIL STRUCTURE DESIGN LOADS

**CHECK BOX IF
LOAD RATED**



Deck clear width over 4 feet?

Golf Cart Load

(1 Ton = 2.0 KIPS Total Load)

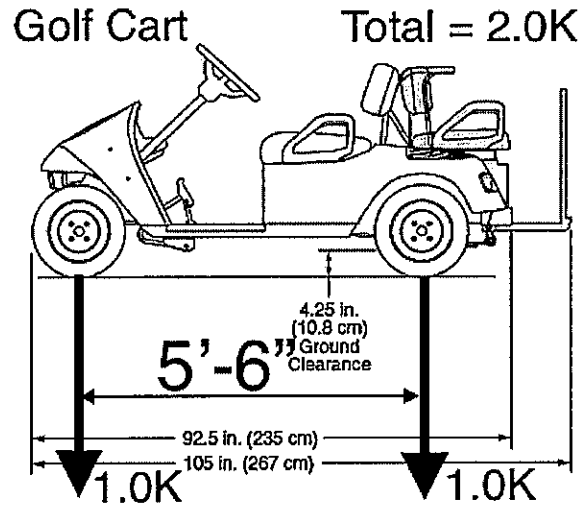
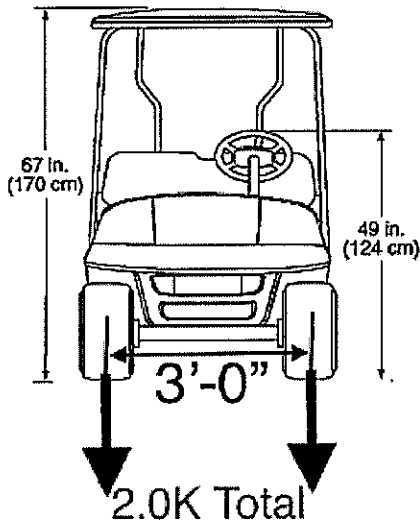

Deck clear width over 5 feet?

UTILITY VEHICLE / GATOR

(1.5 Tons = 3.0 KIPS Total Load)

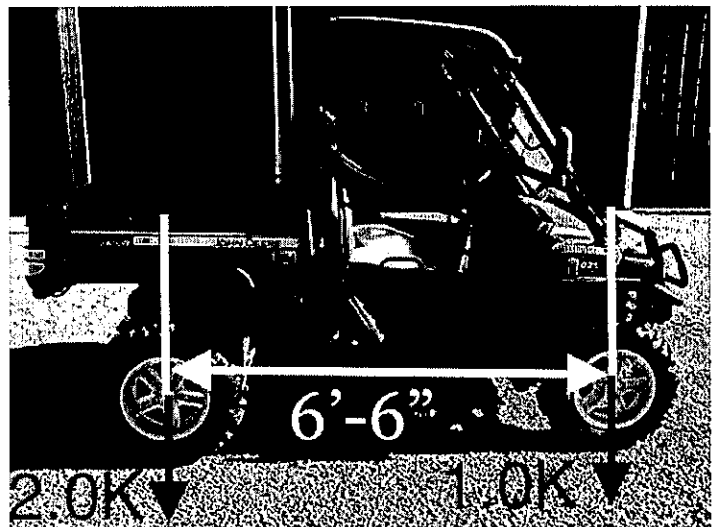
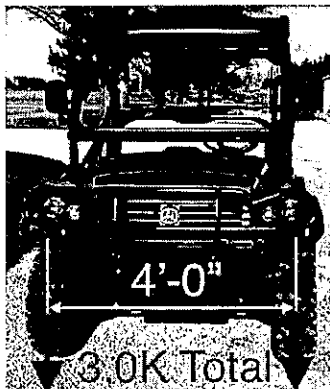

Maryland SHA Vehicles for LOAD RATING

DESIGN VEHICLES: (Remember to Evaluate Lane Loading)

**CHECK BOX IF
LOAD RATED**



RATING VEHICLES

(All numbers in circles are axle loads in 1,000 lbs i.e. ⑧ – 8,000 lb axle load)

LRFR Design Vehicle (Non Permit Load rating):

Deck clear width over 10 feet?

HL-93 (for LRFR only)

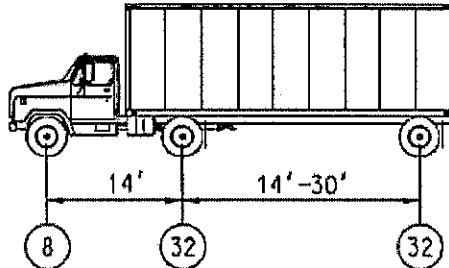

HL-93 (SIA Items 401 and 402)

**72,000 pounds include AASHTO Lane Load and tandem where applicable
(If the LRFD method was used in the design of the structure)**

Deck clear width over 10 feet?

HS-20 TRUCK

(for LFR and ASR)

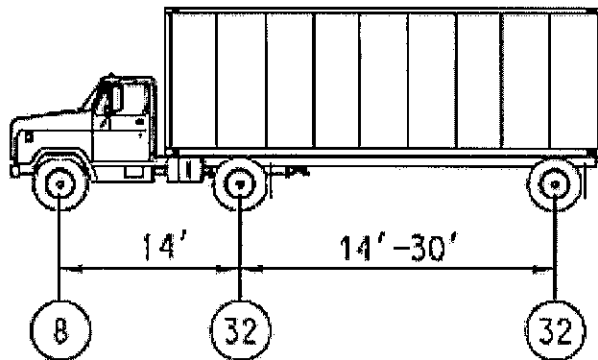

HS-20 (items 409 and 410)

72,000 pounds

AASHTO DEFINITIONS:

(Evaluation not required if HL-93 is rated)

INVENTORY RATING: The Inventory rating level generally corresponds to the customary design level of stresses but reflects the existing bridge and material conditions with regard to deterioration and loss of section. Load ratings based on the Inventory level allow comparisons with the capacity for new structures and, therefore, results in a live load which can safely utilize an existing structure for an indefinite period of time.

OPERATING RATING: Load ratings based on the Operating rating level generally describe the maximum permissible live load to which the structure may be subjected. Allowing unlimited numbers of vehicles to use the bridge at Operating level may shorten the life of the bridge.

**CHECK BOX IF
LOAD RATED**

Maryland SHA Vehicles for LOAD RATING



LEGAL VEHICLES:

Deck clear width over 10 feet?

SINGLE UNIT TRUCKS:

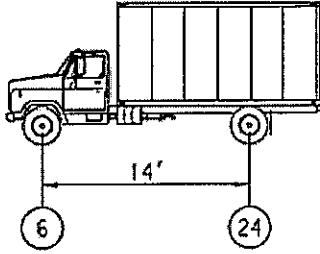

*H-15 (SIA Items 403 and 404)
30,000 pounds*

H-15 SU TRUCK

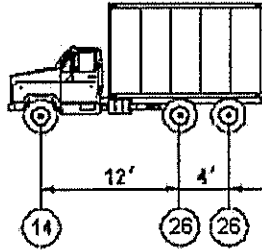

*Type 3 (SIA Items 405 and 406)
66,000 pounds*

MD TYPE 3 SU TRUCK

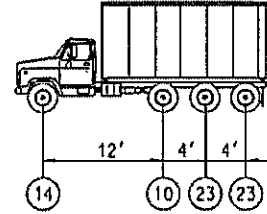

*Type 4 - Reduced Lift Axle (10 kips maximum on lift) (SIA Items 407 and 408)
70,000 pounds*

MD TYPE 4 SU TRUCK

COMBINATION TRUCKS:

Deck clear width over 10 feet?

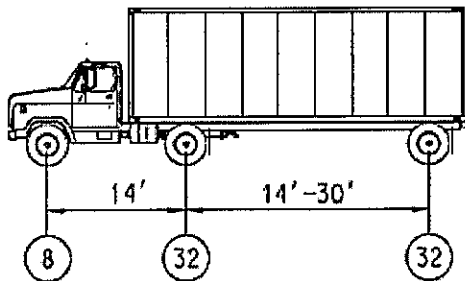

*HS-20 (items 409 and 410)
72,000 pounds
(Evaluation not required if HL-93 is rated)*

HS-20 AASHTO COMBINATION TRUCK

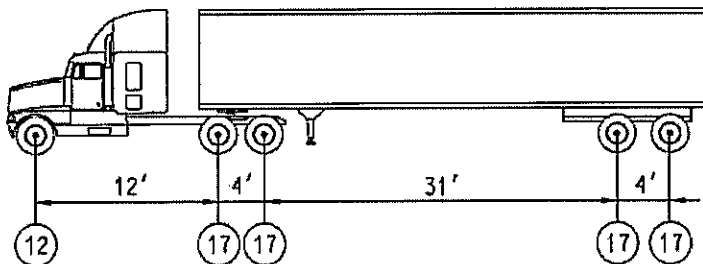

*3S2 (SIA Items 411 and 412)
80,000 pounds*

MD TYPE 3S2 SEMI-TRUCK (COMBINATION)



**CHECK BOX IF
LOAD RATED**

Structure Rated:

PB-050 King Farm Park over Tributary to Watts Branch

Bridge Geometry:

16 span timber bridge with simply supported timber beams.

Overall Length:	151.75	ft
Span Length:	14	ft
Deck Width:	8.00	ft
Deck Plank Width:	5.5	in
Deck Plank Depth:	1.5	in
Deck Plank Moment of Inertia:	1.55	in ⁴
Clear Path Width:	6.54	ft
Beam Depth:	11.25	in
Beam Width:	1.5	in
Beam Moment of Inertia:	177.98	in ⁴

Material: Assume Select Structural Grade Spruce-Pine-Fir

Superimposed Dead Loads:

Load Name	Unit Weight (pcf)	Distributed Load (plf)	
Composite Timber Deck	60	3.44	along deck span
Composite Timber Deck	60	8.57	along beams span
Timber Railing	50	31.09	one railing
Timber Superstructure	50	5.86	one beam

Deck Bending Moment due to Dead Loads:

$$M_{\text{dead}} = 0.69 \text{ lb-ft}$$

$$F_{\text{b,dead}} = 4.01 \text{ psi}$$

Deck Shear due to Dead Loads:

$$V_{\text{dead}} = 13.62 \text{ lbs}$$

$$F_{\text{b,dead}} = 2.48 \text{ psi}$$

Superstructure Bending Moment due to Dead Loads:

$$M_{\text{dead}} = 466.21 \text{ lb-ft}$$

$$F_{\text{b,dead}} = 176.81 \text{ psi}$$

Superstructure Shear due to Dead Loads:

$$V_{\text{dead}} = 166.50 \text{ lbs}$$

$$F_{\text{b,dead}} = 14.80 \text{ psi}$$

Deck Design Capacity:

Bending Moment Capacity:

$$F'_b = F_b C_r C_D C_M C_t C_V C_L$$

Coefficient	Value	Source
C_r	1.04	NDS Sec. 4.3.9
C_D	0.9	NDS Table 2.3.2
C_M	1	NDS Sec. C8.3.3
C_t	1	NDS Table 2.3.3
C_V	1.15	NDS Sec. 4.3.7
C_L	1	NDS Sec. 3.3.3

$$F_b = 500 \text{ psi (Trex Decking)}$$

$$F'_b = 538.20 \text{ psi}$$

Shear Capacity:

$$F'_v = F_v C_D C_M C_t$$

Coefficient	Value	Source
C_D	0.9	NDS Table 2.3.2
C_M	1	NDS Sec. C8.3.3
C_t	1	NDS Table 2.3.3

$$F_b = 360 \text{ psi (NDS Supp. Table 4A)}$$

$$F'_b = 324.00 \text{ psi}$$

Superstructure Design Capacity:

Bending Moment Capacity:

$$F'_b = F_b C_F C_r C_i C_D C_M C_t C_{fu} C_L$$

Coefficient	Value	Source
C_F	1	NDS Supp. Tables 4A, 4B, and 4F
C_r	1.15	NDS Sec. 4.3.9
C_i	1	NDS Sec. 4.3.8
C_D	0.9	NDS Table 2.3.2
C_M	0.85	NDS Supp. Tables 4A-F
C_t	1	NDS Table 2.3.3
C_{fu}	1	NDS Sec. 4.3.7
C_L	1	NDS Sec. 3.3.3

$$F_b = 1250 \text{ psi (NDS Supp. Table 4A)}$$

$$F'_b = 1099.69 \text{ psi}$$

Shear Capacity:

$$F'_v = F_v C_i C_D C_M C_t$$

Coefficient	Value	Source
C_i	1	NDS Sec. 4.3.8
C_D	0.9	NDS Table 2.3.2
C_M	0.97	NDS Supp. Tables 4A-F
C_t	1	NDS Table 2.3.3

$$F_b = 135 \text{ psi (NDS Supp. Table 4A)}$$

$$F'_v = 117.855 \text{ psi}$$

Pedestrian Live Loads:

Uniform Distributed Load:

1 psf

Deck Bending Moment due to Distributed Pedestrian Load:

$$M_{ped} = 2.40 \text{ lb-in}$$

$$F_{b,ped} = 1.17 \text{ psi}$$

Deck Shear due to Distributed Pedestrian Load:

$$V_{ped} = 3.96 \text{ lb}$$

$$F_{b,ped} = 0.72 \text{ psi}$$

Beam Bending Moment due to Distributed Pedestrian Load:

$$M_{ped} = 202.13 \quad \text{lb-in}$$

$$F_{b,ped} = 6.39 \quad \text{psi}$$

Beam Shear due to Distributed Pedestrian Load:

$$V_{ped} = 4.81 \quad \text{lb}$$

$$F_{b,ped} = 0.43 \quad \text{psi}$$

Point Load: 1 lb

Deck Bending Moment due to Pedestrian Point Load:

$$M_{ped} = 0.34 \quad \text{lb-ft}$$

$$F_{b,ped} = 2.00 \quad \text{psi}$$

Deck Shear due to Pedestrian Point Load:

$$V_{ped} = 0.50 \quad \text{lb}$$

$$F_{b,ped} = 0.09 \quad \text{psi}$$

Beam Bending Moment due to Pedestrian Point Load:

$$M_{ped} = 8.25 \quad \text{lb-in}$$

$$F_{b,ped} = 0.26 \quad \text{psi}$$

Beam Shear due to Pedestrian Point Load:

$$V_{ped} = 0.50 \quad \text{lb}$$

$$F_{b,ped} = 0.044 \quad \text{psi}$$

Vehicle Live Loads:

Golf Cart:

Deck Bending Moment due to Golf Cart:

$$M_{GC} = 102.27 \quad \text{lb-ft}$$

$$F_{b,GC} = 595.04 \quad \text{psi}$$

Deck Shear due to Golf Cart:

$$V_{GC} = 409.09 \quad \text{lb}$$

$$F_{b,GC} = 49.59 \quad \text{psi}$$

Beam Bending Moment due to Golf Cart:

$$M_{ped} = 1585.23 \quad \text{lb-in}$$

$$F_{b,ped} = 50.10 \quad \text{psi}$$

Beam Shear due to Golf Cart:

$$V_{ped} = 387.18 \quad \text{lb}$$

$$F_{b,ped} = 34.416 \quad \text{psi}$$

Utility Vehicle:

Deck Bending Moment due to Utility Vehicle:

$$M_{GC} = 340.91 \quad \text{lb-ft}$$

$$F_{b,GC} = 1983.47 \quad \text{psi}$$

Deck Shear due to Utility Vehicle:

$$V_{GC} = 545.45 \quad \text{lb}$$

$$F_{b,GC} = 66.12 \quad \text{psi}$$

Beam Bending Moment due to Utility Vehicle:

$$M_{ped} = 1977.27 \quad \text{lb-in}$$

$$F_{b,ped} = 62.49 \quad \text{psi}$$

Beam Shear due to Utility Vehicle:

$$V_{ped} = 535.71 \quad \text{lb}$$

$$F_{b,ped} = 47.619 \quad \text{psi}$$

Deck Load Ratings:

Load Type	Allow Bending Stress - DL Bending Stress (psi)	LL Bending Stress (psi)	Moment Factor
Distributed	534.19	1.17	458.14
Point	534.19	2.00	267.10
Golf Cart	534.19	595.04	0.90
Utility Vehicle	534.19	1983.47	0.27

Load Type	Allow Shear Stress - DL Shear Stress (psi)	LL Shear Stress (psi)	Shear Factor
Distributed	321.52	0.72	446.37
Point	321.52	0.09	3536.76
Golf Cart	321.52	49.59	6.48
Utility Vehicle	321.52	66.12	4.86

Load Type	Moment Load Rating	Shear Load Rating	Deck Load Rating
Distributed	458.14	446.37	446.37 psf
Point	267.10	3536.76	267.10 lb
Golf Cart	0.90	6.48	1795.48 lb
Utility Vehicle	0.27	4.86	807.97 lb

Superstructure Load Ratings:

Load Type	Allow Bending Stress - DL Bending Stress (psi)	LL Bending Stress (psi)	Moment Factor
Distributed	922.87	6.39	144.47
Point	922.87	0.26	3539.43
Golf Cart	922.87	50.10	18.42
Utility Vehicle	922.87	62.49	14.77

Load Type	Allow Shear Stress - DL Shear Stress (psi)	LL Shear Stress (psi)	Shear Factor
Distributed	103.05	0.43	240.91
Point	103.05	0.04	2318.73
Golf Cart	103.05	34.42	2.99
Utility Vehicle	103.05	47.62	2.16

Load Type	Moment Load Rating	Shear Load Rating	Load Rating
Distributed	144.47	240.91	144.47 psf
Point	3539.43	2318.73	2318.73 lb
Golf Cart	18.42	2.99	5988.84 lb
Utility Vehicle	14.77	2.16	6492.44 lb

Load Rating Summary:

Load	Load Rating	Load Rating Factor	Controlling Member
85 PSF Pedestrian Load	144.47	1.7	Beams (Moment)
Point Load (lb)	267.10	-	Deck (Moment)
Golf Cart (lb)	1795.48	0.9	Deck (Moment)
Utility Vehicle (lb)	807.97	0.27	Deck (Moment)



City of Rockville, Maryland
Department of Public Works
111 Maryland Avenue
Rockville, Maryland 20850